Disclaimer

This document contains information that is the proprietary and confidential property of INNCOM by Honeywell. By acceptance hereof, each recipient agrees to use the information contained herein only for the purpose anticipated by INNCOM by Honeywell, and not to disclose to others, copy or reproduce, any part hereof without the written consent of INNCOM by Honeywell. The recipient agrees to return this document to INNCOM by Honeywell immediately upon request.

- **DISCONNECT POWER BEFORE BEGINNING INSTALLATION. ELECTRICAL HAZARD:** Can cause electrical shock or equipment damage.
- **Must be installed by a trained , experienced technician.**
- **See device specific product guides for load specifications.**

Table of Contents

1. WIRING GUIDE 24VAC X47 ("A3" OPTION)	2
2. THERMOSTAT WIRE CONNECTIONS:	3
3. SYSTEM SPECIFIC WIRING GUIDES	4
4. LOW VOLTAGE WIRING	6
5. FIELD SIDE WIRING	7
6. DOCUMENT INFORMATION	8

1. Wiring Guide 24VAC X47 (“A3” option)

See detailed wiring guides for specific system types on the following page.

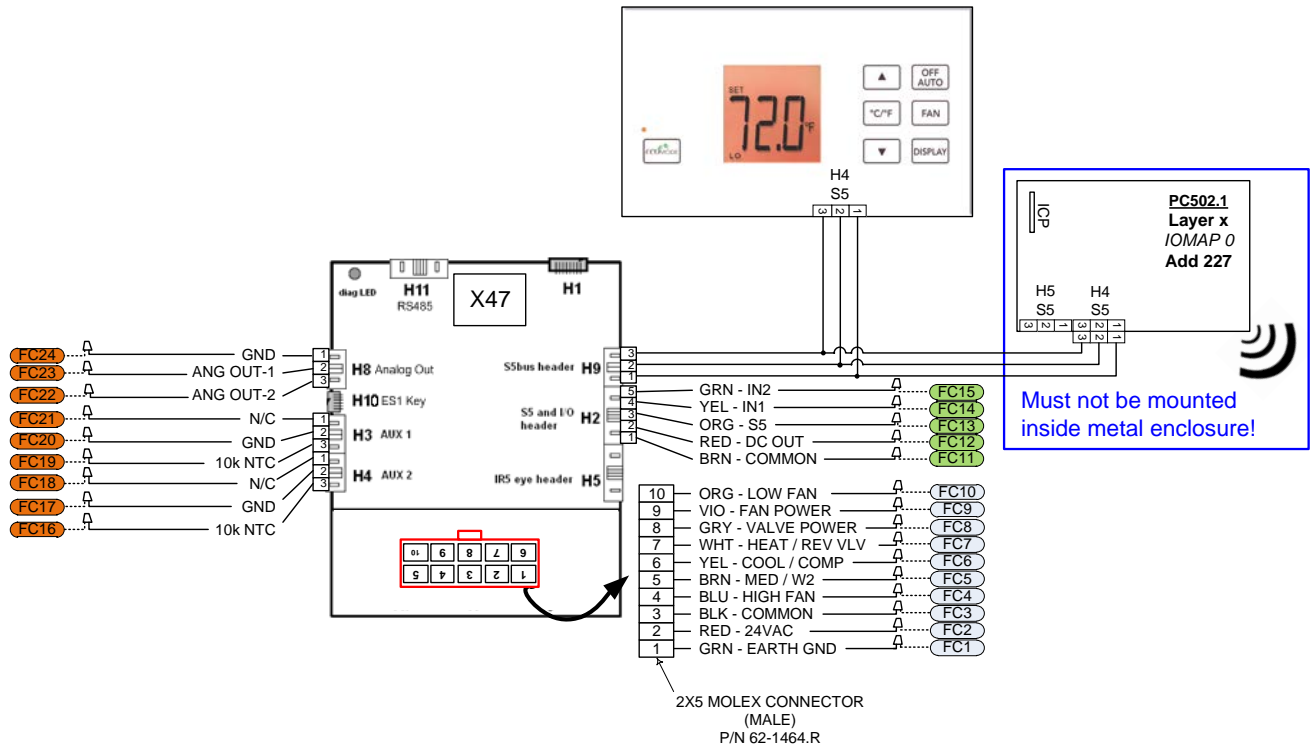

2. Thermostat wire connections:

HVAC INTERFACE

Connection	Color	Function
FC1	Green	EARTH GROUND
FC2	Red	24 VAC POWER
FC3	Black	24 VAC COMMON
FC4	Blue	HIGH FAN RELAY
FC5	Brown	MED FAN RELAY/ HEAT RELAY(STAGE 2)
FC6	Yellow	COMPRESSOR CONTACTOR
FC7	White	HEAT RELAY(STAGE 1)/ REVERSING VALVE
FC8	Grey	24 VAC VALVE POWER
FC9	Violet	24 VAC FAN POWER
FC10	Orange	LOW FAN RELAY

LOW VOLTAGE INTERFACE

Connection	Color	Function
FC11	Brown	DC GROUND
FC12	Red	DC OUT
FC13	Orange	S5 BUS
FC14	Yellow	INPUT 1
FC15	Green	INPUT 2

FIELD SIDE INTERFACE

Connection	Color	Function
FC16	Orange	10K NTC (REMOTE THERMISTOR INPUT)
FC17	Red	GROUND
FC18	Brown	NO CONNECTION
FC19	Orange	10K NTC (REMOTE THERMISTOR INPUT)
FC20	Red	GROUND
FC21	Brown	NO CONNECTION
FC22	Orange	ANALOG OUTPUT-2
FC23	Red	ANALOG OUTPUT-1
FC24	Brown	GROUND

3. System Specific Wiring Guides

Generic Single Stage Heat/Cool

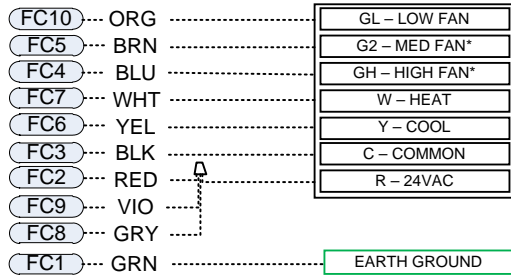

Unused Fan Outputs

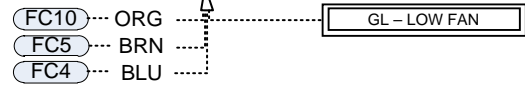

*Unused fan outputs in any HVAC Type shall be tied to FC10

Heat Pump North (HpO)-Single Stage Heat

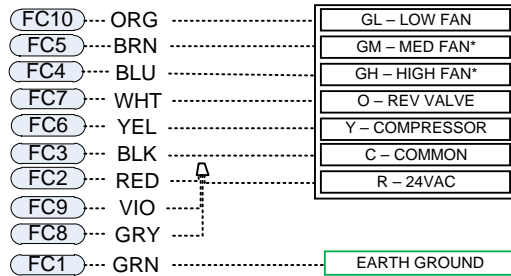

Heat Pump North (HpO)-Two Stages Heat

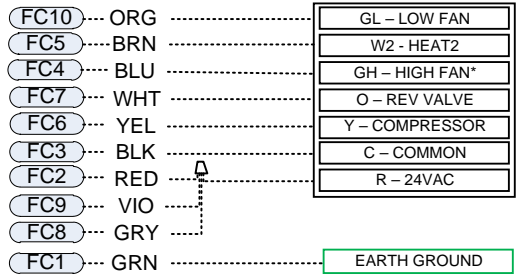

Heat Pump South (HpB)-Single Stage Heat

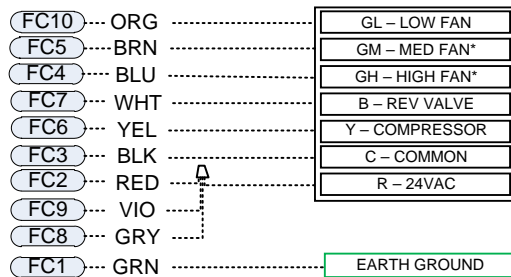

Heat Pump South (HpB)-Two Stages Heat

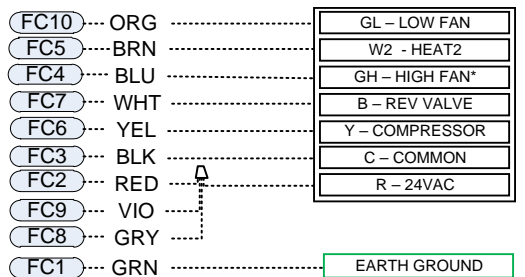

2 Pipe Change-Over

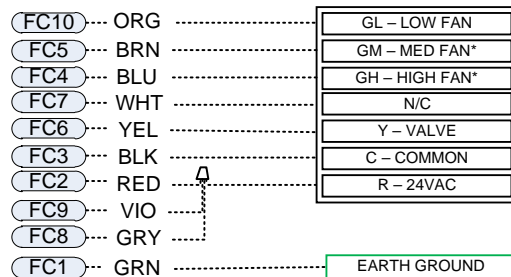

2 Pipe Change-Over with Back-up Electric Heat

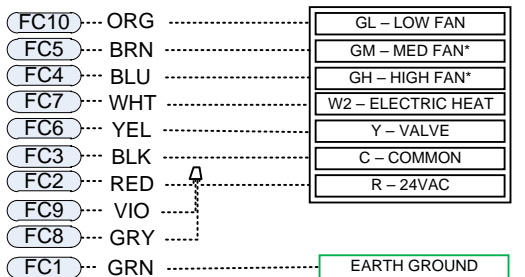

Cool Only System

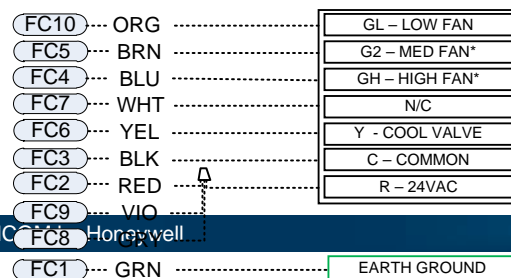

Heat Only System

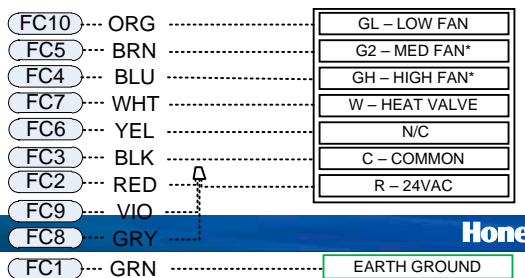

4. Low Voltage Wiring

Door Contact Only

Closed Door=Closed Contact

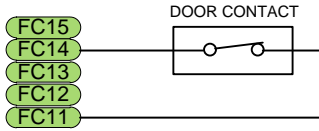

Window Contact Only

Closed Window=Closed Contact

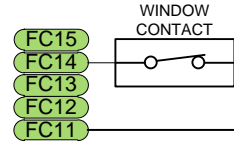

Door & Window Contact

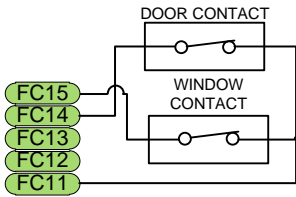

Window Contact & PIR Sensor

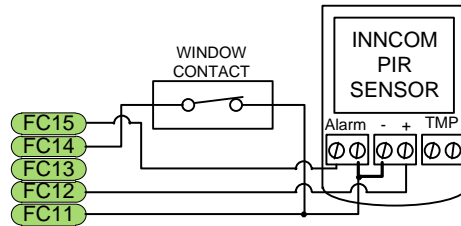

Door Contact & PIR Sensor

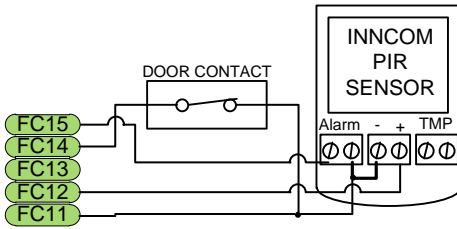

PIR Sensor Only

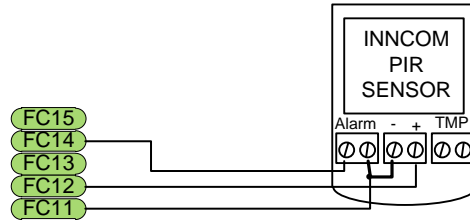

If Multiple Window Contacts in Series

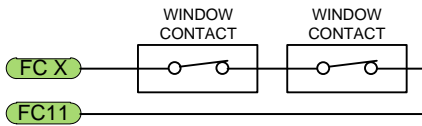

If Multiple PIR Sensors in Series

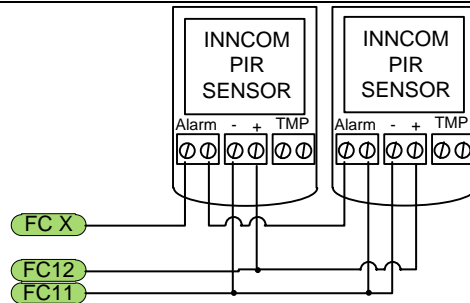

S5 Bus

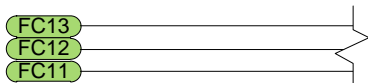

S5 BUS:
TO OTHER S5
ROOM DEVICES

5. Field Side Wiring

Variable Fan connection using ANG OUT-1

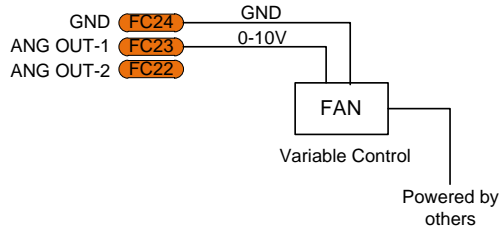

Variable Fan connection using ANG OUT-2

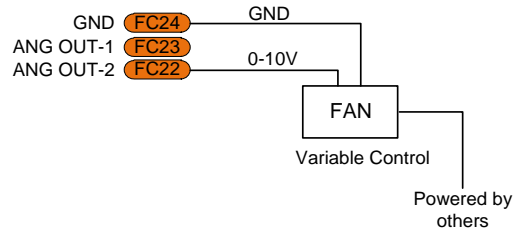

Heat/Cool Valve connection using ANG OUT-1

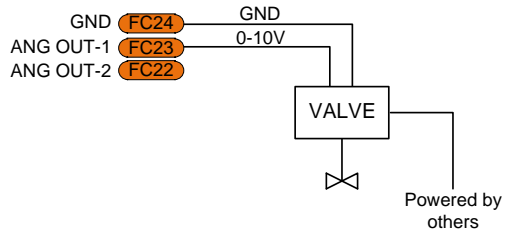

Heat/Cool Valve connection using ANG OUT- 2

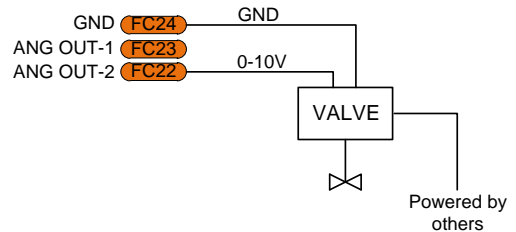

Remote Thermistor

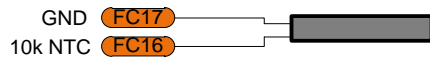

6. Document Information

Author

Jasmeet Talwar

INNCOM by Honeywell
277 West Main Street
Niantic, CT 06357
(860) 739 4468

File

Source:

\$/FO_100_INNtool/Documents/Wiring Guides/INNtool_MODEVA_24VAC_Wiring_Diagram.doc

Distribution:

T:\FTP\Eng_Data\Hotels\FO_100_INNtool\Documents\Wiring Guides\INNtool_MODEVA_24VAC_Wiring_Diagram.pdf

Version

2017/12/05 Version 3.2